



ENGLISH

PLANMECA
ProMax 3D s



Profound understanding of anatomy



The unique Planmeca ProMax 3D product family offers equipment for all maxillofacial imaging. All volume sizes from the smallest special cases to whole head images are available. Planmeca ProMax 3D s is designed to obtain complete information on patient anatomy in the minutest detail. It is ideal for imaging of small details and optimal for e.g. single implant and wisdom tooth cases, as well as for implant surgery and orthodontic and periodontal treatment. The unit provides digital panoramic, cephalometric, and 3D imaging, as well as advanced imaging software tools to comply with every possible need in dental radiology.



Planmeca ProMax 3D s features an amorphous silicon flat panel which produces accurate, distortion-free images for 3D reconstruction. Unlike image intensifier sensors that use old vacuum tube technology and multi-step focusing, flat panels use single step image readouts with no geometric distortion, no loss of sensitivity, and therefore no need for frequent calibration.

Planmeca's proprietary 3D reconstruction algorithm converts the original 2D transillumination images to a 3D volume study, making it the core component

for high quality 3D imaging. The algorithm handles high contrast objects, eliminating effectively the artefacts caused by implants, metal fillings or braces.

The reconstructed image volume consists of more than 200 million voxels. These voxels are isotropic, enabling accurate 1:1 measurements and ensuring geometric relations throughout the image. The extremely small voxel size, $100^3 \mu\text{m}^3$, produces a detailed high-resolution 5 lp/mm image without artefacts.



Planmeca ProMax 3D s is a genuine all-in-one unit including digital panoramic, digital cephalometric, and 3D digital imaging, all in the same unit, saving office space and investment costs. A unique SmartPan imaging system uses the same 3D sensor also for panoramic imaging. This eliminates need to change sensors, making the workflow faster and safer. SmartPan also allows the user to select the most optimal panoramic layer after the exposure. This innovative, versatile, and dynamic imaging device will open up new possibilities for on-site dentists.

In modern dentistry, the demand for implant surgery is steadily growing, which has created a need for more advanced X-ray imaging systems. To meet the needs of modern surgical dentistry and to supply clear, dependable imaging in a three-dimensional format with limited

patient dose, Planmeca ProMax 3D s utilises Cone Beam Volumetric Tomography (CBVT) technology.

Cone beam scan is ideal for dedicated imaging of the maxillofacial complex as it uses a pyramid-shaped beam to scan the entire region of interest in a single semicircle scan, as opposed to a medical CT that takes multiple axial slices in multiple full circle scans. The volumes are manipulated by computer software into one cylindrical image for viewing. During the scan, each image is generated using a short X-ray pulse instead of continuous radiation. The total scanning time is 18 seconds for one volume, but the actual exposure time is only 3 seconds at shortest.

This technology reduces patient radiation dose considerably and forms stroboscopic X-ray effect which,

together with the short rotation scan (only 200 degrees in minimum), virtually eliminates artefacts, contributing to outstanding image quality.

The Planmeca ProMax platform's unique SCARA technology (Selectively Compliant Articulated Robot Arm) enables free geometry based on image formation. Planmeca's patented, computer-controlled SCARA robotic arm can produce any movement pattern required, ensuring perfectly accurate and reliable image volume positioning and enabling image volume diameter adjustment. All controls are accessed via a full colour graphical user interface in the language of your choice.

Thanks to the original, technologically advanced design, any Planmeca ProMax can be upgraded into a 3D Cone Beam Volumetric Tomography unit.



Impacted canine

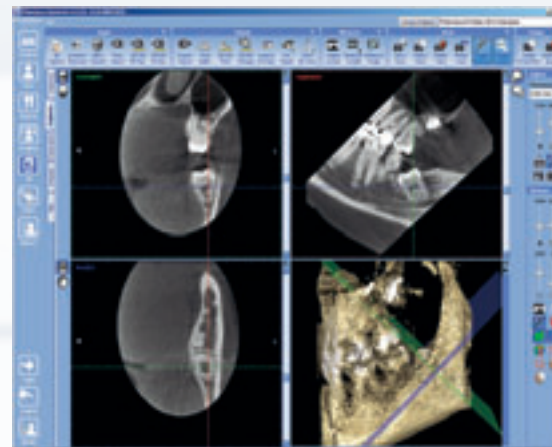

Wisdom tooth extraction
The extraction would be relatively easy.

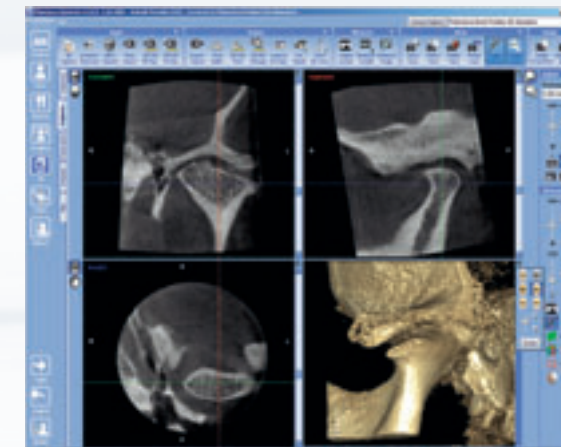

TMJ study
The condyle is displayed sharply. The condition of the temporomandibular joint is clearly visible. Malignant finding can be seen in the right condyle head.

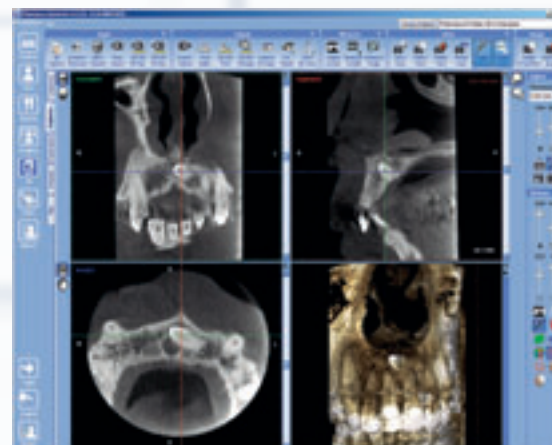
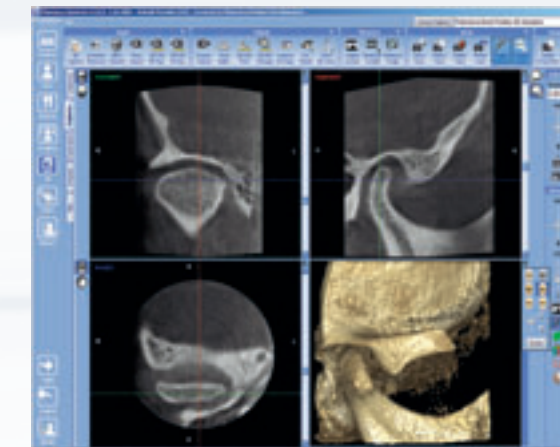

Supernumerary tooth
An extra tooth found in maxilla.

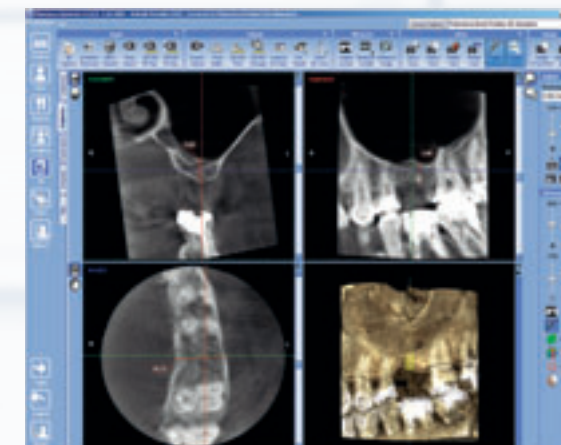

Implant case
The upper right first molar is missing. The image clearly shows that there is just enough bone to place an implant.

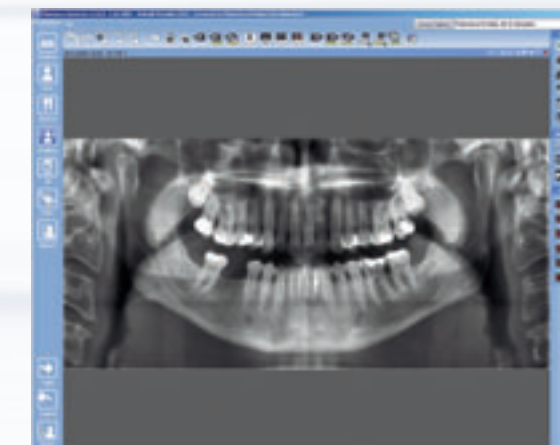

SmartPan system produces high-quality panoramic images.

Unequaled imaging programs

Planmeca ProMax 3D s complies with a multitude of diagnostic requirements: those of implantology, endodontics, periodontics, orthodontics, as well as dental and maxillofacial surgery, and TMJ analysis.

The 50 x 80 mm image size is optimum for most implantology applications. The basic volumes can also be stitched together to generate a larger view of patient anatomy.

Planmeca ProMax 3D s produces high-resolution volumetric studies of the mandible and maxilla for analysing the available bone structure, the location of the mandibular canal, and the correct position

for the implant. Pre-surgical planning will reach a new level of precision, as the prospective site becomes visible in all three imaging planes: sagittal, axial, and coronal.

Third molars, maxillary cuspids, supernumerary teeth, and impactions challenge the clinician to identify the tooth's orientation. By using Planmeca ProMax 3D s, all anatomical structures, angles and orientations become clearly visible.

Planmeca ProMax 3D s studies accompanied by digital cephalometric images provide full visualisation of all classes of orthodontic malocclusion. This is highly advantageous for orthodontic planning,

as time is saved and patient radiation dose reduced. Planmeca ProMax 3D s provides the image data in the correct anatomic 1:1 ratio, with no need to correct for geometric magnification.

Planmeca ProMax 3D s also provides high-resolution TMJ studies for true and accurate evaluations of the joint arthritides, condylar morphology, and the condyle-fossa relationship.

With its high resolution (5 lp/mm) and advanced reconstruction technology, Planmeca ProMax 3D s establishes the new standard for 3D dental radiology.

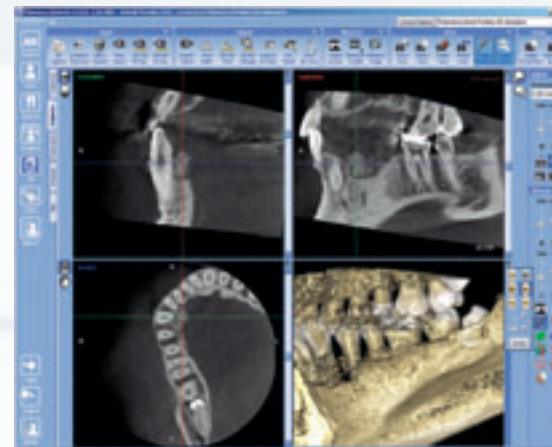

Finding in canine area
A suspicious mass found behind the lower right canine.

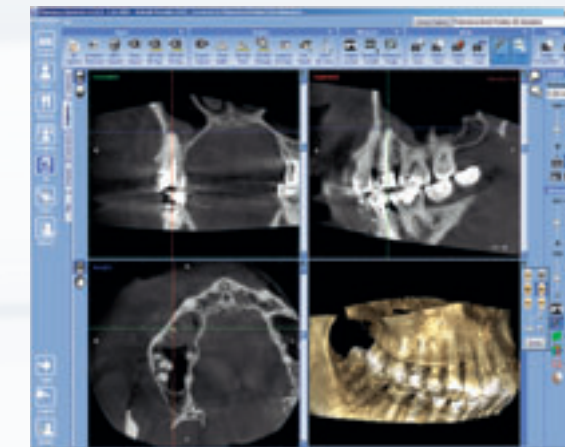

Finding in sinus
Swelling in sinus mucosa

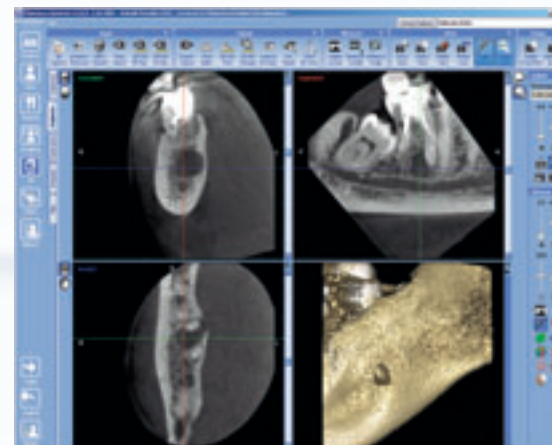

Lesion in right mandible
A radiolucent lesion is clearly visible in the right mandible.
The probable cause is an unsuccessful root treatment.

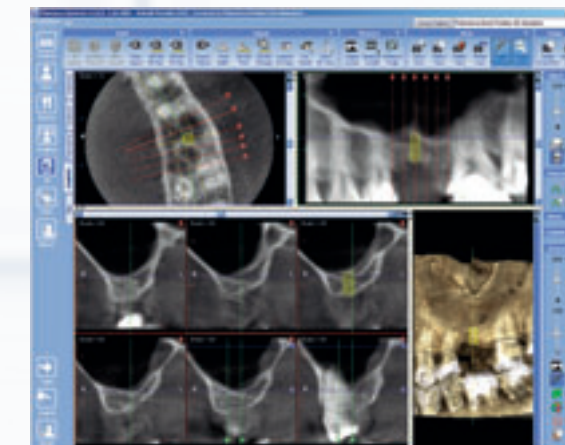

Planmeca Romexis 3D Implant Planning module

Planmeca Romexis 3D Explorer, the 3D image acquisition software for Planmeca ProMax 3D s, enables flexible viewing in all three relevant projections: axial, coronal, and sagittal. The software incorporates a re-slicing feature, which enhances the projections and enables real-time three-dimensional viewing from the desired angle. A rendered 3D view provides a realistic overview of the anatomy.

With the Planmeca Romexis 3D Explorer software, each patient study can be stored on a CD with Planmeca Romexis 3D Viewer for others to view.

The optional Planmeca Romexis 3D Cross Sections module produces cross-sectional images of anatomy along with the defined panoramic curve. The image number and their exact positions can be freely chosen.

The 3D Cross Sections module also includes reconstructed panoramic view, which creates a panoramic image from the acquired volume of data without the undesired artefacts, commonly visible in normal panoramic images. As the image is reconstructed through software, the user can determine the location and thickness of the focal trough.

The optional Planmeca Romexis 3D Implant Planning module offers tools for implant placing and nerve drawing. The implant placements are determined with the help of an implant model sized of an actual implant. The drawing tool allows clear marking of the mandibular nerve.

The Planmeca Romexis 3D TMJ module supports accurate diagnosis of the TMJ area. The size, the location and the

alignment of the projections can be freely defined and a dedicated view is provided for each TMJ. Both left and right TMJ's are available in one view for easy comparison.

Planmeca Romexis software has optional DICOM functionality, which allows 3D studies to be transferred to other implant planning software or any other software that receives images in DICOM format. Studies can also be transferred to PACS or to a high quality DICOM printer in the network. The image data can also be used for ordering Planmeca ProModel, a patient specific physical model that serves as a beneficial tool for preoperative planning of advanced implant, oral and maxillofacial surgeries.

Planmeca Romexis is pure Java based software that runs in various operating systems and modern web environments.

Planmeca Romexis software

Planmeca Romexis is a complete dental imaging software, including all dental imaging modalities: intraoral, panoramic, cephalometric, 3D imaging, dental tomography as well as intraoral video and still camera imaging. With a complete set of tools for image viewing, enhancement, measurements, and annotations, Planmeca Romexis also improves the diagnostic value of radiographs. Printing, image import and export, and DICOM functionalities are also included.

Planmeca Romexis platform fully integrates digital imaging with the patient's other clinical data. The system provides direct image capture from Planmeca's X-ray equipment, and interfaces with 3rd party devices via TWAIN. Together with Planmeca's X-ray equipment, Planmeca Romexis provides a unique safety feature especially useful for teaching environment: the X-ray image capture is inhibited until the supervisor has approved the student's image capture request.

Planmeca Romexis computer recommendations

	Planmeca Romexis client workstation	Planmeca Romexis server
Processor	2 GHz Core Duo or equivalent	3 GHz Core Duo or equivalent
RAM	4 GB	4 GB
Hard disk space	40 GB	2 x 500 GB (RAID1 mirroring)
Graphics card	ATI or NVIDIA, 128 MB minimum memory	Not required
Monitor	1280 x 1024	1024 x 768
Peripherals	CD R/W or DVD R/W drive	CD R/W or DVD R/W drive
Backup medium	None necessary	DAT or equivalent
Operating system	Windows XP (32 bit) Windows Vista (32 or 64) Mac OS X Mac OS X support subject to contract	Windows XP Pro (32 bit) Windows 2003 (32 or 64) Windows Vista (32 or 64)
Other	Java platform (Java Virtual Machine 1.6 or later)	Java platform (Java Virtual Machine 1.6 or later)

The disk space requirements are determined by digital images. Thus the space requirements vary, but a rough estimate is in the order of 1 MB per 2D X-ray image, 7–9 MB per extraoral image, depending on a variety of image specific factors, and 250 MB per 3D image.

It is recommended to use the same computer as an application server and as a database server. If Planmeca Romexis server computer is also used for client activities, the hardware should meet both client and server specifications.

These specifications are recommended minimum requirements. Not meeting them may lead to degraded performance.

DICOM compatibility

- Media Storage – saving images into removable DICOM media
- Print – printing images on film or paper with a DICOM medical printer
- Storage – saving images into DICOM image archive
- Query/ Retrieve – importing digital images from DICOM image archive
- Worklist – importing a patient list from DICOM patient management
- Storage Commitment – confirmation of a successful image storage

Planmeca ProMax 3D s

X-ray beam	Cone
Focal spot	0.5 mm, fixed anode
Image detector	Amorphous silicon flat panel
Gray scale	15 bit
Detector resolution	630 x 1024 pixels, pixel size 127 µm x 127 µm
Voxel size	100 x 100 x 100 µm, isotropic 200 x 200 x 200 µm, isotropic
Image acquisition	Single 200 degree rotation
Total scan time	18 s, pulsed X-ray
Reconstruction time	15–60 s
Standard volumes (diam. x height)	Ø50 x 80 mm (child mode Ø42 x 68 mm) Ø50 x 50 mm (child mode Ø42 x 42 mm)
Stitched volume (w x d x h)	90 x 60 x 130 mm
3D reconstruction server	Proprietary Feldkamp type back projection reconstruction algorithm Improved Artefact Removal (IAR) for high contrast object compensation

Example installation

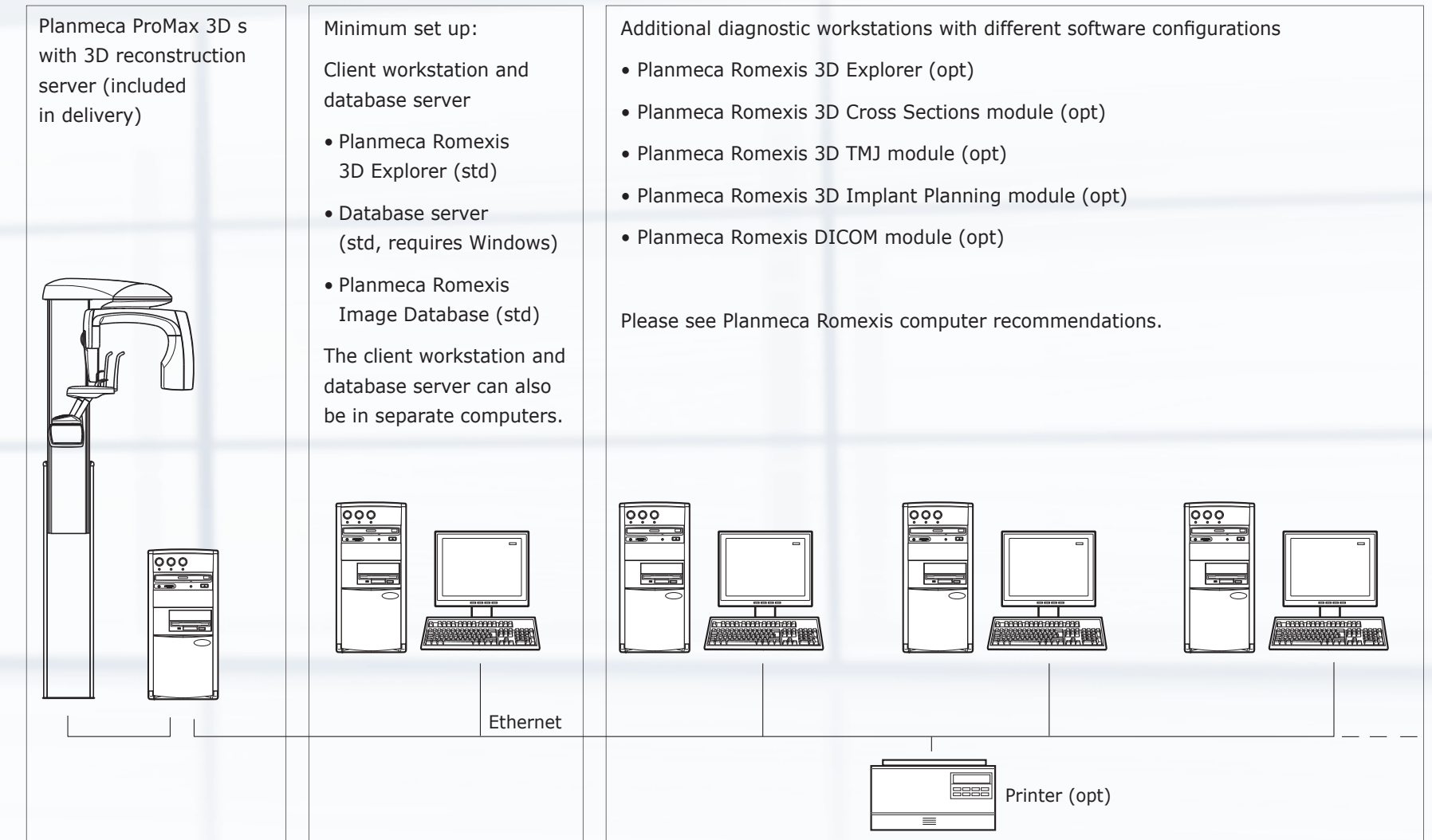

Dimensions and space requirements

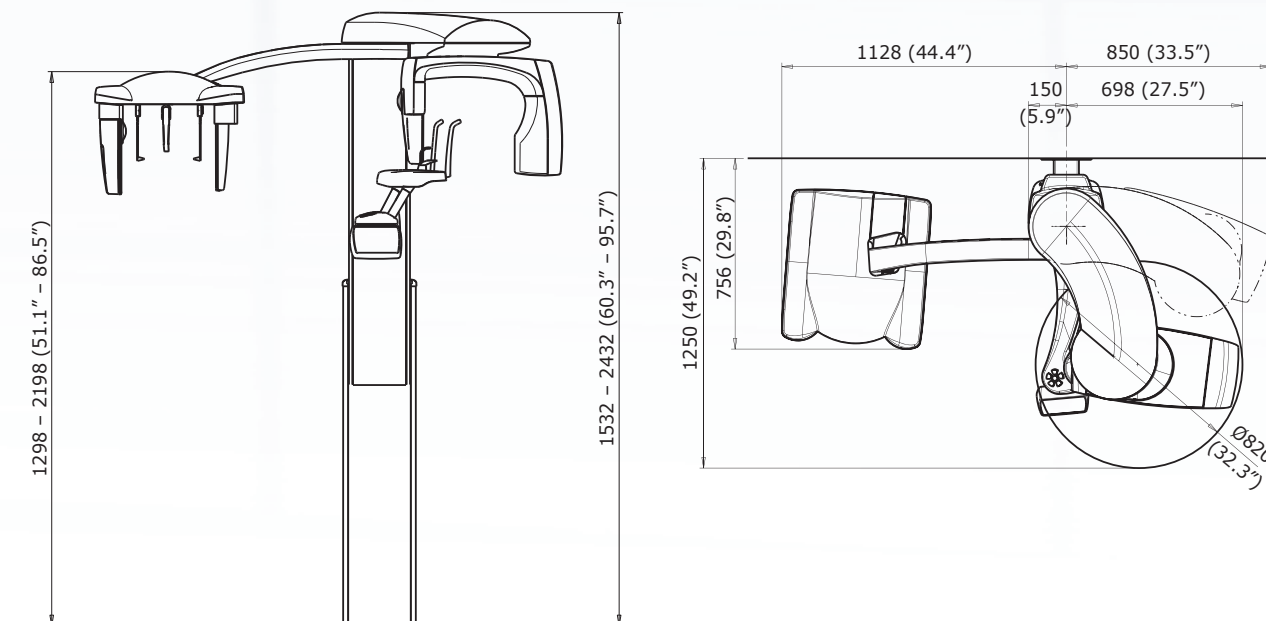

		Planmeca ProMax 3D s	Planmeca ProMax 3D s with cephalostat
Physical space requirements	Width	96 cm (38 in.)	194 cm (76 in.)
	Depth	125 cm (49 in.)	125 cm (49 in.)
	Height*	153–243 cm (60–96 in.)	153–243 cm (60–96 in.)
Minimum operational space requirements	Width	150 cm (59 in.)	215 cm (85 in.)
	Depth	163 cm (64 in.)	163 cm (64 in.)
	Height*	243 cm (96 in.)	243 cm (96 in.)
Weight		113 kg (lbs 248)	128 kg (lbs 282)

*The maximum height of the unit can be adjusted for offices with limited ceiling space.



Planmeca Oy designs and manufactures a full line of high technology dental equipment, including dental care units, panoramic and intraoral X-ray units, and digital imaging products. Planmeca Oy, the parent company of the Finnish Planmeca Group, is strongly committed to R&D, and is the largest privately held company in the field.



Planmeca Oy
 Asentajankatu 6 | 00880 Helsinki | Finland
 tel. +358 20 7795 500 | fax +358 20 7795 555
 sales@planmeca.com | www.planmeca.com

Images may contain optional items not included in standard delivery. Available configurations and features may have country or area specific variations. Some products displayed above may not be available in all countries or areas. Rights for changes reserved.